

RS SWING

Operating Manual

■ RS SWING

○ AY-P004~P011 / S033X

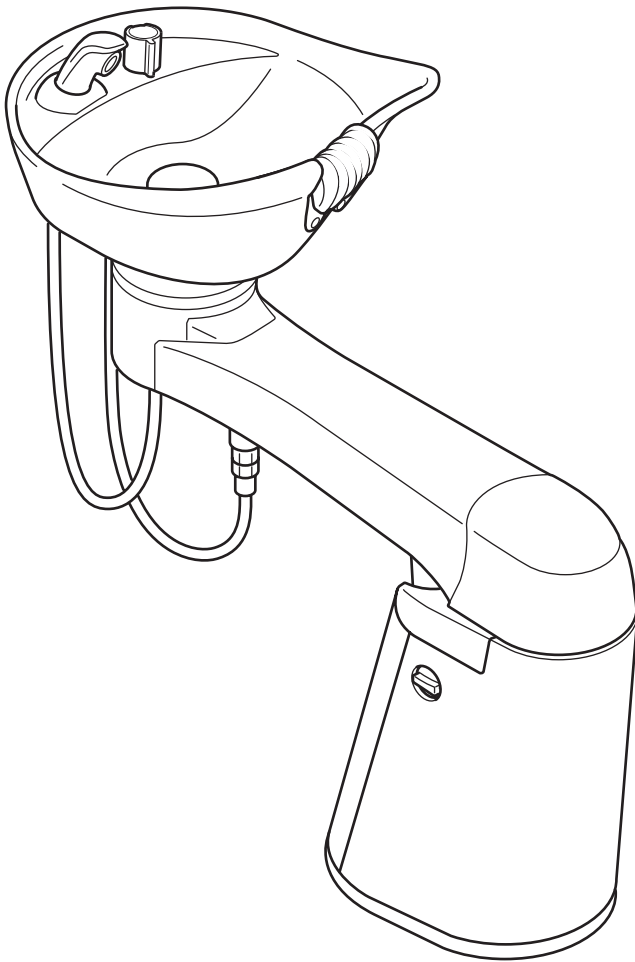

Table of Contents

Description of Warning Symbols	2
Safety Precautions	2
Precautions for Use	5
Position of Warning Labels	7
Precautions for Basin	7
Before Using This Product	7
Precautions for Plated Parts	8
Name of Parts	8
Accessories	9
Preparations	9
How to Use	10
Guiding Clients	15
Maintenance	17
Daily Inspections	21
Parts Replaced on a Regular Basis	22
Before Requesting Repairs	22
Standard Duration of Use	23
Consumable Supplies	23
Disposing of This Product	23
After-sales Service	24
Specifications	24
Product Dimensions	25
Procedures for Daily Inspections	26
MEMO	28

Thank you for purchasing this Takara Belmont product.

The instructions contained in this booklet should be thoroughly read and understood before use.

Using this product before reading this operating manual may result in an accident.

This product is an industrial shampoo unit designed for barbers and hair salons.

Only use this product for its intended purpose and do not use it for non-hairdressing work.

Keep this manual and refer back to them when required.

This product is designed for shampooing and hair/scalp care.

Please contact the nearest dealer or Takara Belmont directly in case your operating manual is unreadable due to being soiled or ripped.

Description of Warning Symbols

■ Before using this product







The “Safety Precautions” and “Precautions for Use” contained in this manual should be thoroughly read and understood before use.

■ Precautions listed here





The precautions listed here are to ensure that this product can be used safely, and to prevent any danger or risk to the person using this product or those around them.

These precautions are important for ensuring safety. Adhere to these precautions at all times. Takara Belmont is not responsible for any damage or risk to the person using this product or those around them due to accidents if this product is used without adhering to the “Safety Precautions” and “Precautions for Use”. In this case, the person failing to adhere to the “Safety Precautions” and “Precautions for Use” will be responsible for any damage or risk incurred. Detailed descriptions of symbols are provided below. Read and understand these symbols thoroughly before reading this manual.

■ Symbols

 Warning	If this symbol is ignored and the product is used, “there is the risk of death or serious injury”.
 Caution	If this symbol is ignored and the product is used, “there is the risk of light or moderate injury or physical damage”.
Note	Description of “ideal points to adhere to for safety”.
 Common danger, warning and caution notifications	 Guidance or instruction regarding common user actions
 Common prohibited actions	 Notification of high temperature warning CAUTION Hot water
 Prohibited disassembly or repairs/modifications Disassembly Prohibited	

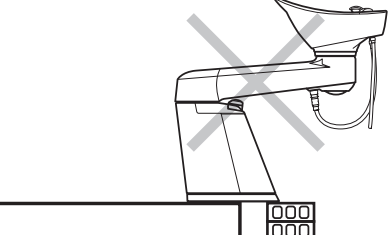
Safety Precautions (Adhere to these precautions at all times)

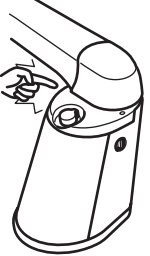
 Warning	
 Install on a stable area. Install the main unit on a flat, firm floor, and fix it securely. Failure to follow this instruction may cause the main unit to fall over.	 Adjust the water temperature while checking the temperature by hand. When adjusting the temperature of the water, reduce the volume of water, point the showerhead away from the client and check the temperature by hand. Take care when doing so, as hot water may come out of the showerhead.
	 Do not move the arm when you are temperature adjustment Do not move the arm when you manipulate the temperature control handle. Failure to follow this instruction may cause injury.
 Do not lean on the basin. Leaning on the basin while shampooing etc., may cause the basin to fall over or rotation arm to move, leading to injury. Also, coloring dyes on the neck cushion or basin may stain the user’s clothes.	



Warning



Disassembly and repairs/modifications are prohibited.

Disassembly Prohibited

Disassembly, repairs and modifications must not be conducted by people other than qualified repair technicians. Failure to follow this instruction may cause electrocution, fire or abnormal operation, leading to injury.

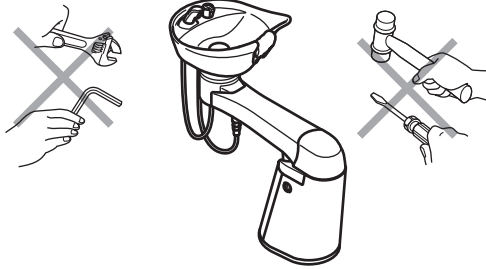

Do not insert fingers into movable parts.

Do not insert fingers into movable parts. Failure to follow this instruction may cause injury.

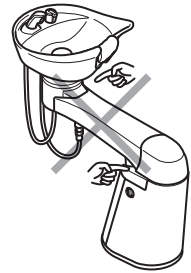

Return the temperature control knob to an appropriate position after using hot water.

- Return the temperature control knob to an appropriate position after using hot water at high temperature. Continuing to use the hot water with the knob in the hot temperature position may cause burns.
- Using other equipment that share the same water/hot water supply source at the same time may cause unstable water temperature. If multiple equipment are to be used, turn the temperature control knob slowly to adjust the water temperature.



CAUTION
Hot Water

Do not use hot water (boiling water) of 60°C or higher.

Using hot water of 60°C or higher may deform or damage the basin, shower head and tap, etc.



Do not climb on basin or arm.

Do not climb on, lean on or apply excessive force to parts such as the basin, arm, etc. Failure to follow this instruction may damage the product or cause it to fall over.



Do not slide the basin swiftly.

Slide the basin gently, paying attention to avoid hitting people or objects. Failure to follow this instruction may cause breakage of the product or injury.



Warning



Do not subject the unit to shocks.

Do not subject the unit to shocks. Failure to follow this instruction may cause damage, leading to injury.

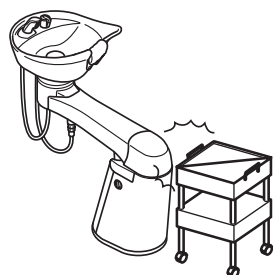











Do not spray areas other than the basin with water.

- Take care not to spray areas other than the basin with water. If water does come in contact with areas other than the basin, wipe them dry as soon as possible. Water entering the main body may cause malfunctions or a ground leakage fire.
- Take care not to allow water to drip on the floor. If water does drip on the floor, wipe it dry as soon as possible. Failure to follow this instruction may damage the floor, or cause water leakage.



Warning

<p> Only use this product for its intended purpose and do not use it for non-hairdressing work. This product is an industrial product designed for barbers and hair salons. Only use this product for its intended purpose and do not use it for non-hairdressing work.</p>	<p> Do not use this product if the coating is peeling. If the coating of the tap (water control knob) is peeling, immediately contact the nearest dealer or Takara Belmont directly and replace it. Failure to follow this instruction may cause injury.</p>
<p> Do not turn the water fully on with the shower head in the shower head bracket. Failure to follow this instruction may cause water to spill out of the basin, covering the customer with water. When turning the water on with the shower head in the shower head bracket, check the surrounding area and turn the water control knob slowly.</p>	<p> Do not use the product in a place where freezing is expected. Failure to take this precaution may result in breakage of parts, thus resulting in water leaks. Repair of breakage due to freezing will result in fees being charged even during the warranty period. If freezing is expected, maintain the room temperature at 0°C or above by using a heater.</p>
<p> Do not use outdoors. This product is designed for indoor use. Do not install this product outdoors or within a vehicle. Be sure to only use this product inside a barber or hair salon. Failure to follow this instruction may cause malfunctions or damage to the main body.</p>	<p> Open the Stop Valve at the beginning of the day and close it at the end of the day. Make sure to close the Stop Valve at the end of each day to avoid water leakage over the night.</p>
<p> Do not drink the hot water. This product is designed for washing hair. Do not drink the hot water. The water quality may cause diarrhea or stomach pain.</p>	<p> Do not use it without the cover. Failure to follow this instructions may cause burn injuries by accidentally touching hot parts.</p>
<p> When you move the chair to check the position of the ball and the arm. Slide the basin gently, paying attention to avoid hitting people or objects. Failure to turn the water off completely may cause water leakage.</p>	<p> Do not use this product with the cover broken. Replace the cover if it breaks. Continuing to use this product with a broken cover may cause a malfunction or an accident.</p>
<p> Check the set water temperature before using shower. Before using shower, please always check the set water temperature. Failure to follow this instructions may cause burn injuries by hot water.</p>	

Precautions for Use



Caution



Do not wipe with chemicals or apply heat.

Failure to follow this instruction may cause deformation or discoloration. If chemicals adhere on to the covers, wipe them dry as soon as possible.

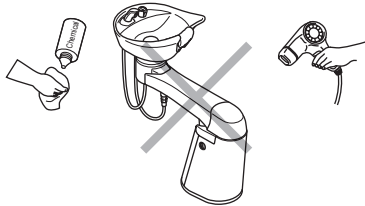

Close the tap firmly.

After use or shampooing is complete, turn the tap firmly in a clockwise direction and turn the water off completely. Failure to turn the water off completely may cause water leakage.



Do not cover the drain outlet when this product is not going to be used.

Do not cover the drain outlet with the drain cap, towel, or shampoo cloth after finishing the work. Water may overflow the basin when water is improperly discharged or a small amount of hot water is discharged due to an increase in water pressure during the night, resulting in water leaks.

Be sure to remove the trap cover from the drain outlet when the product is not in use.

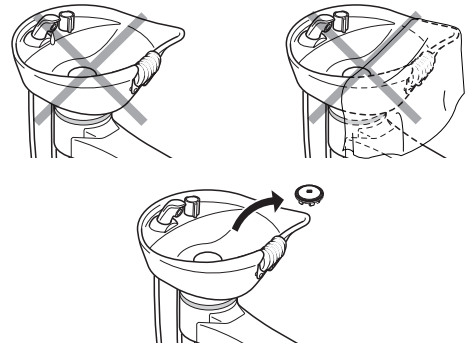

Do not use strongly acidic or strongly alkaline cleaning solvents.

Do not use cleaning solvents containing mainly caustic soda (NaOH) or caustic potash (KOH) to clean the drain pipe, etc. Never pour thinners, alcohol, nail polish remover, gasoline or kerosene into the drain. Failure to follow this instruction may cause breakage of the drain hose.



Clean the hair catcher regularly.

Clean the hair catcher as regularly as possible. Continuing use of the hair catcher without cleaning it may cause the drain to become blocked with hair, leading to water overflowing or unhygienic conditions. Try to clean the hair catcher after each shampoo.



Do not leave the showerhead immersed in water.

If pressure in the water pipes decreases due to repairs that follow water stoppages, the water in the basin may flow back through the showerhead.



Avoid direct sunlight or heat from a stove.

Avoid direct sunlight or heat from a stove. Failure to follow this instruction may cause discoloration or degradation of the product.

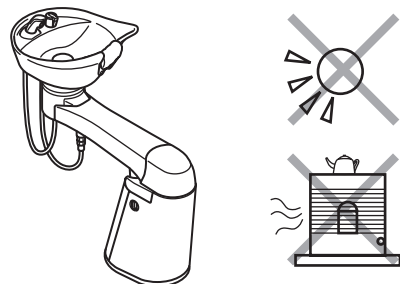

If chemicals spill on to this product, wipe them away as soon as possible.

If chemicals such as hair dyes spill on to this product, wipe them away as soon as possible. Failure to follow this instruction may cause discoloration, deterioration or deformation. Also, if chemicals spill on to the floor, wipe them away as soon as possible.

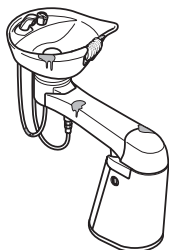

Pay attention to handling of the neck cushion.

Do not touch or hit the neck cushion with a cutting tool such as scissors, or an edged tool (including long nails). Failure to follow this instruction may cause flaws on the surface or breakage of the neck cushion.



Caution



Do not drop heavy objects on to the basin.

Do not place or drop heavy objects on to the basin. Failure to follow this instruction may cause breakage such as flaws or cracks on the basin.



Set the water temperature for this product to 80°C or less.

Failure to follow this instruction may cause malfunction or breakage in parts such as the stop valve, check valve, flexible pipe and thermostat water valve.



Do not use an abrasive compound.

Do not use an abrasive compound to clean the water faucet fixtures (showerhead, showerhead receptacle, water control knob). Use of an abrasive compound, sponge with abrasive compound, or hard cleaning tools, such as wire wool or a nylon scrubbing brush, may damage the fixture surface.



Pay attention to handling of the neck cushion.

Do not touch or hit the neck cushion with a cutting tool such as scissors, or an edged tool (including long nails). Failure to follow this instruction may cause flaws on the surface or breakage of the neck cushion.



Do not hit the main unit with objects.

Do not hit the main unit with hard objects. Failure to follow this instruction may cause deformation or breakage of the main unit.



Return the shower head to the shower head bracket so that the Air bubble unit faces the basin.

Failure to follow this instruction may cause water to spill out of the basin or splash on the customer with water. Return the shower head to the shower head bracket so that the air bubble unit faces the basin.



In cold regions, ensure that water is removed.

When using this product in the cold regions, open the maintenance cover and open the check valve filter to remove water and prevent freezing. Failure to follow this instruction may cause water leakage.



Do not wet the shower head bracket with water.

Do not wet the shower head bracket with water. Failure to follow this instruction may cause water leaks.

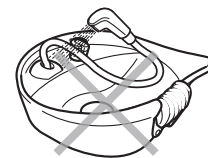

Do not touch the hot water supply pipe or mixing pipe.

The hot water supply pipe or mixing pipe may become very hot. Do not touch the pipes directly.



After use, wipe water away from all parts other than the basin.

Leaving the main unit with water on it may cause breakage of the product, or dirt may become hard to remove.



Do not use peppermint or aroma oil.

Do not use peppermint or aroma oil containing menthol. Failure to take this precaution may damage the resin parts, such as the showerhead, showerhead bracket, shower hose, water control knob, neck cushion, hair catcher, and drain cap.



Always wipe the floor clean if it is wet.

Wipe the floor as soon as possible if it is wet after shampooing. Failure to follow this instruction may damage the floor or cause degradation to parts in contact with the floor.



Be careful of the chair (especially the legrest and the footstep).

If you rotate the chair with the legrest extended or the legrest faced towards the shampoo unit, the chair can come in contact with the unit, causing breakage of the unit or customer injuries.



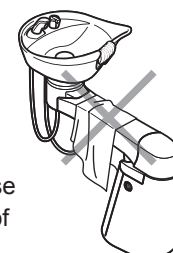

Do not hang any shampoo capes on the unit.

Failure to follow this instructions may make the coloring agents on the shampoo cape to get in contact with the unit and cause deformation or discoloration of the unit.



Position of Warning Labels

⚠ CAUTION	⚠ CAUTION	⚠ CAUTION
		
Do not use hot water of 60°C and higher. Using hot water at 60°C and higher may deform or damage the ceramic bowl, the shower head or the faucet handle.	If chemical such as hair dye attached to the equipment, wipe it out immediately, or it may cause discoloration or deterioration.	Do not use chemical detergent mainly containing caustic soda (NaOH) & caustic potash (KOH) for cleaning drain pipes, etc. This may cause damage on the drain hose, etc.
For other cautions, please read the operating instruction carefully before use.		

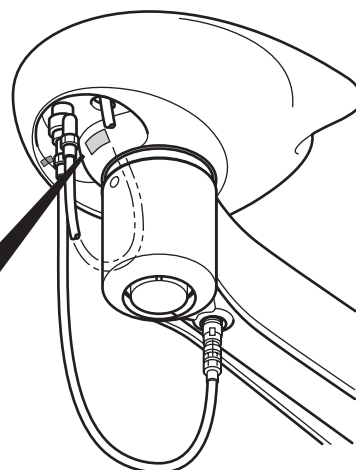

 注意 CAUTION
終業時にはハンドルを右に回し 止水バルブを閉じてください。

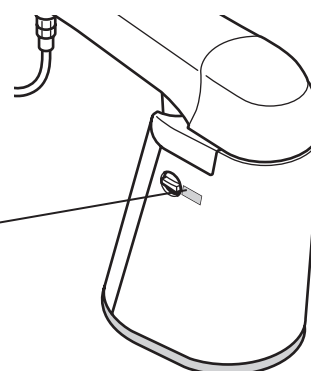

Precaution on Basin

This product employs a ceramic basin. Since bending or deformation cannot be avoided when forming the basin, the position, height, or shape of the neck differs slightly from product to product.

Before Using This Product

- The back wash basin is a shampooing product designed for performing back shampooing*1 or hair/scalp care.
- Check that all accessories have been attached properly.
- Please note that the gap between the backrest and the basin when the backrest is reclined may vary slightly from product to product.

*1 Back shampooing: the user stands behind the basin and performs shampooing from the back (back position).

Precautions on Resin (Plated) Parts

- Resin plating is adopted for part of the water stop knob, Shower head bracket and the temperature control knob.
- Plating is a thin, hard metal film applied to the surface that may crack or peel due to corrosion or aged deterioration.
- Flaws or cracks may occur on the plated surface due to impacts from falling objects.
- Flaws or cracks may occur on the plated surface when a hard object hits the surface.
- Peeling of the plating may occur from flaws or cracks on the plated surface.



Caution

Check to ensure that there are no flaws, cracks, or peeling of the plated surface of the knobs before using the product. If peeling is observed, immediately stop using the product and contact your closest dealer or Takara Belmont. Continued operation may result in injuries.

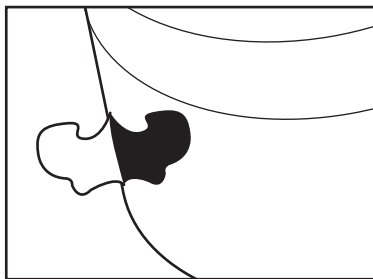

Example of Peeling of the Plated Surface

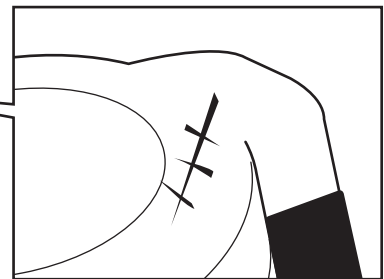
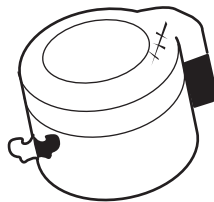

Example of Flaws on the Plated Surface

Name of Parts

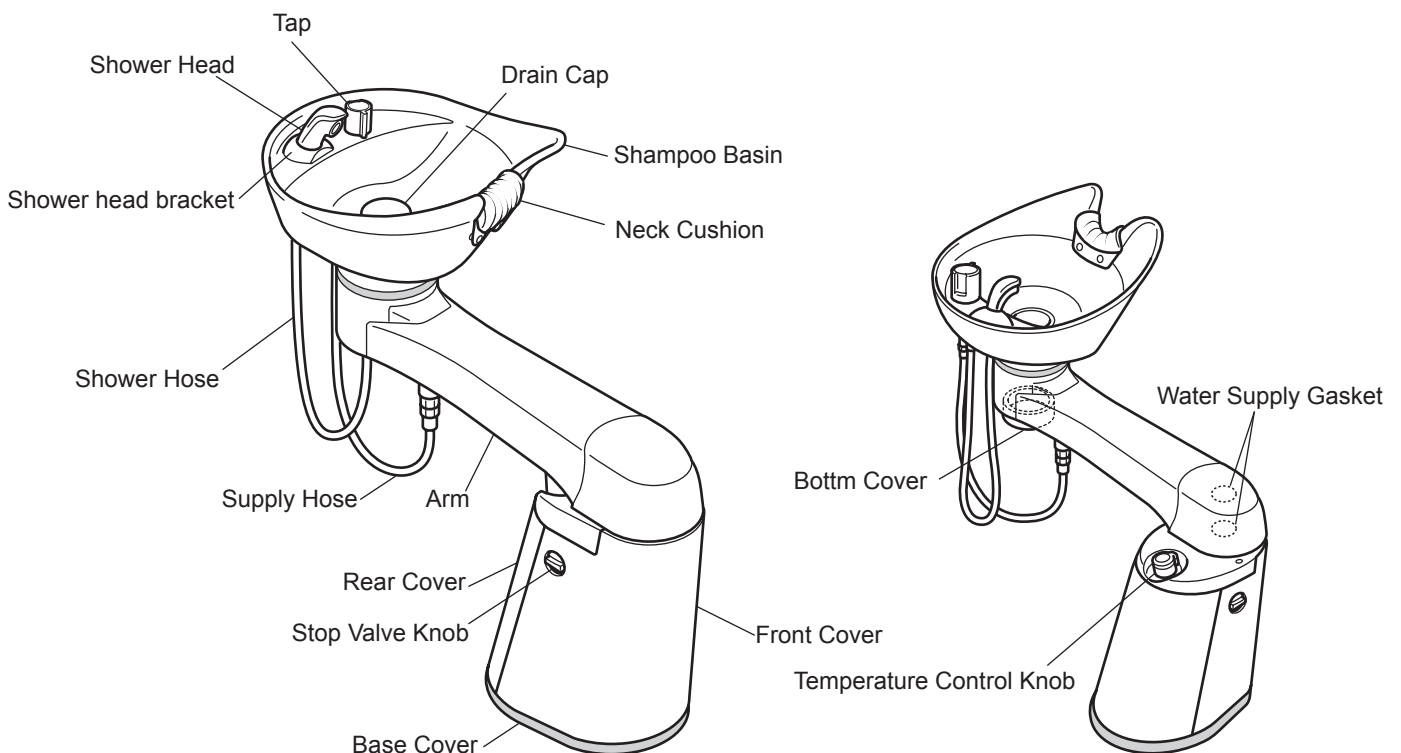

Accessories

□ Neck cushion...1

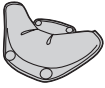

□ Drain cap...1

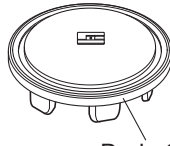

Drain Cap Packing

□ Hair catcher...1



□ Air bubble unit disassembling kit...1

(Wrench,
Showerhead Cleaning
Instruction Manual)

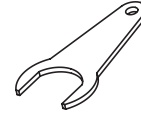

□ Operating Manual(This manual)...1

□ Installation Manual...1

Preparations

■ Attach neck cushion on the basin

- 1 As shown in the illustrations, check the proper direction of the neck cushion and fit it to the basin along the basin edge.

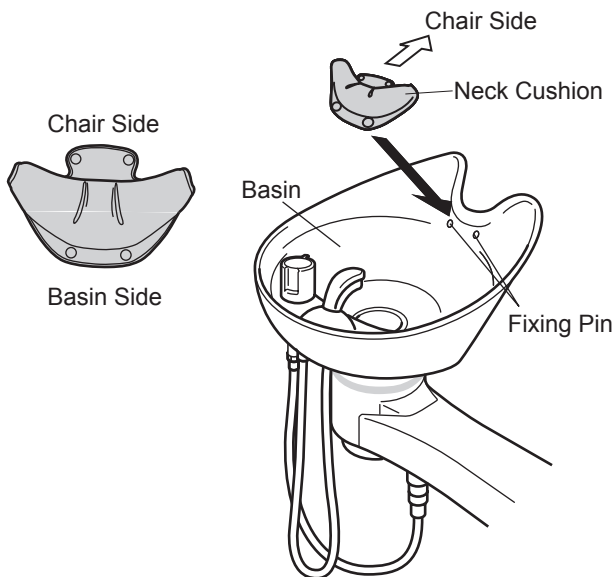

Caution

Check the front and back.
When the cushion is mounted in
the wrong direction, it may contact
the backrest.

- 2 Secure the hooks of the neck cushion to the fixing pins on the inner side of the basin.

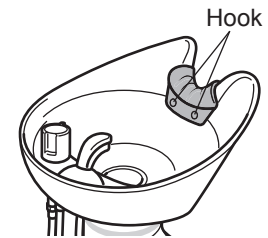

The fixing pins are detachable. Be careful
not to lose them.

- 3 While shaping the neck cushion along the basin edge, secure the hooks of the neck cushion to the fixing pins on the outer side of the basin

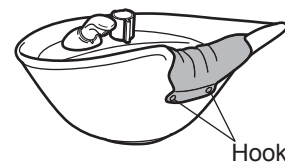

■ Remove neck cushion

- 1 Hold the hooks when removing the neck cushion.



Caution

Applying excessive force to remove the neck cushion may damage the parts.

Note

The neck cushion is consumable supply. Replace it if it is extremely dirty or
the surface has deteriorated. (available at additional cost)

How to Use

■Using the Shower head

1. To pull out with a shower head.

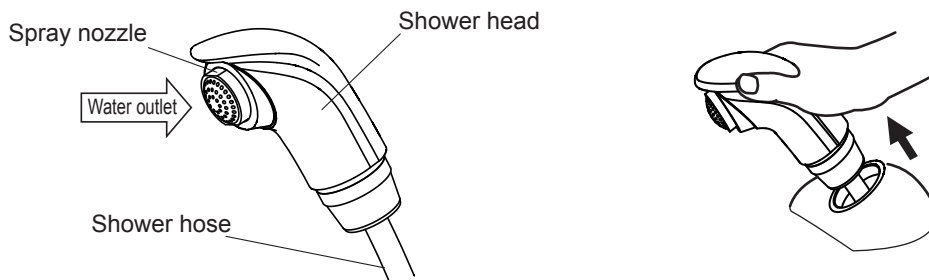

2. It will be housed in the shower head bracket as in When you are finished using the figure.

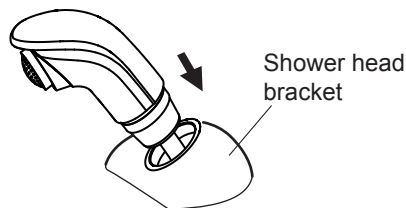

⚠ Caution

- Do not discharge a strong water stream when the showerhead is in the showerhead receptacle. Failure to take this precaution may result in system failure due to spilled water or damage to the floor.
- Return the shower head to the shower head bracket after use so that the spray nozzle is pointed toward the basin.

■Adjusting the volume of water

1. A left (counter clockwise) rotation of the tap increases the amount of hot water. A full left (counter clockwise) rotation of the tap (approximately 130 degrees) will output the maximum amount. A full right (clockwise) rotation of the tap will stop the water.

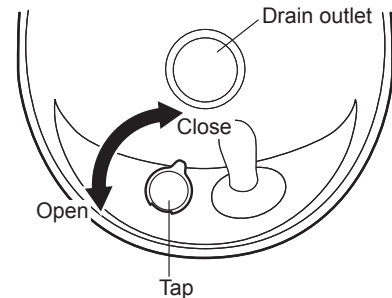

⚠ Caution

- When the basin is not being used, turn the tap firmly full right (clockwise) to turn the water off properly. Failure to do this may cause water leakage.
- After shampooing, do not cover the drain with the drain cap, towel or shampoo cloth, etc. If the hot water may come out accidentally or hot water is trickle due to an increase in water pressure at night, this may cause water to spill out from the basin, leading to water leakage.
- If the drainage becomes sluggish, immediately stop using the product, and contact the nearest dealer or Takara Belmont directly. The drain pipe may be clogged with dirt, resulting in water leakage of the inside of the product.
- Operate the tap only after removing metallic objects, such as rings and wrist watches, etc. Failure to follow this instruction may result in contact between the metal and the cap of tap resulting in flaws or cracks on the plated surface and thereby causing peeling of the plating.
- Before using the product, check that there are no flaws, cracks, or peeling of the plated surface of the tap. If the plating is peeled off, immediately stop using the product and contact the nearest dealer or Takara Belmont directly. Continued operation may result in personal injury.

Depends on the environment or condition that it is used in, the product may have the following conditions. If adjustment or replacement is required, contact the nearest dealer or Takara Belmont directly.

Note

- A gushing sound may be emitted from the basin unit. (Adjustment is required.) This sound is due to water flowing fast through pipes as a result of high water pressure or water volume control, and is not indicative of a defective product. This gushing sound may be reduced by adjusting the water pressure.
- The tap may become stiffer. (Replacement is required.) This is due to deterioration of packing of movable parts or a lack of grease as a result of aging. Replacement of the packing or other parts, or a recoating of grease is required. (available at additional cost)

■Adjusting the water temperature

1. Turn the temperature control knob in the H or C direction to set the temperature to an appropriate level.
When turning to the H direction, water becomes warm, and when turning to the C direction, water becomes cold.



Caution

When adjusting the water temperature, reduce the volume of water, point the showerhead away from the client and check the temperature by hand. Take care when doing so, as hot water may come out of the showerhead.

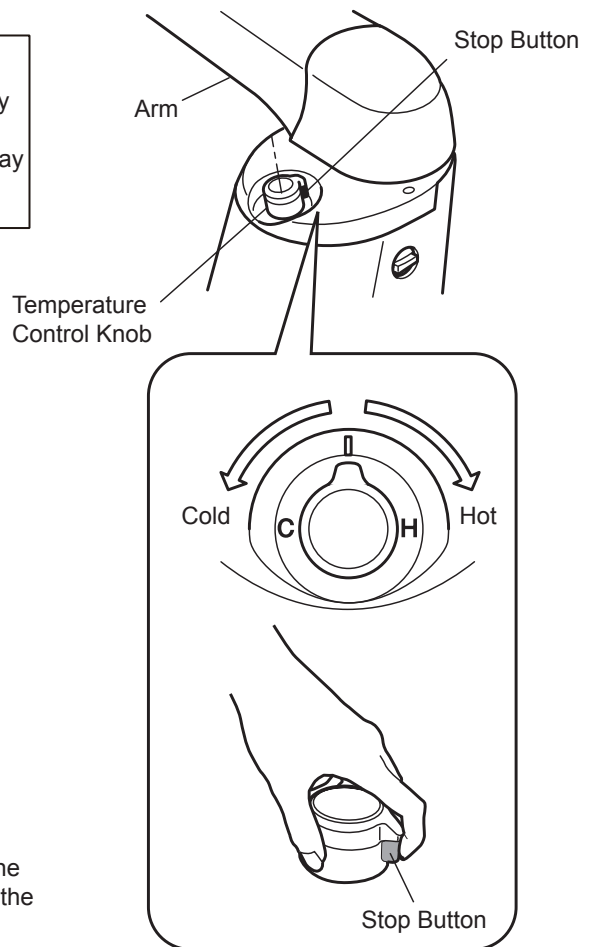

2. To use hot water at high temperature (40°C and higher), turn the temperature control knob in the H direction while holding down the stop button.

 **Caution**

- Return the temperature control knob to an appropriate position after use. Continuing to use the hot water with the knob in the hot temperature position may cause burns.
- Using other equipment that shares the same water/hot water supply source at the same time may cause unstable water temperature. Do not execute any quick operation while adjusting the temperature.
- Operate the temperature control knob only after removing metallic objects such as rings and wrist watches, etc. Failure to follow this instruction may result in contact between the metal and cap of temperature control knob resulting in flaws or cracks on the plated surface and thereby causing peeling of the plating.
- Before using the product, check that there are no flaws, cracks, or peeling of the plated surface of the temperature control knob. If the plating is peeled off, immediately stop using the product and contact the nearest dealer or Takara Belmont directly as it may result in personal injury. Continued operation may result in personal injury.

*For safety reasons, this product is designed so that hot water of approximately 53°C or higher is not output.
(Conditions: In the case that the supply pressure of water and hot water are the same, normal water temperature is 20°C and hot water temperature is 60°C.)

Note

- Depends on the operating environment or conditions, the water discharge amount may change significantly when controlling the hot water temperature. This phenomena occurs when the hot water temperature exceeds the recommended values (60°C to 80°C), there is significant difference in the water supply or hot-water supply pressure, or multiple devices are used at the same time – it is not a product failure.
- The temperature of discharged water and the preset temperature may differ depending on the operating environment or conditions.
(The product is designed so that the temperature of the discharged water will be about 40°C when the temperature control knob is turned toward the H position and locked in that position.)
This phenomena occurs when the hot water temperature exceeds the recommended values (60°C to 80°C), there is significant difference in the water supply or hot-water supply pressure, or multiple devices are used at the same time - it is not product failure. The temperature of discharged water may be set at approximately 40°C when the temperature of hot water or the pressure of the water/hot water supply is adjusted and the locking position of the temperature control knob is adjusted.

■ To fill up basin with water

1. To accumulate hot water for emulsification of hair color, rotate the drain cap in the clockwise direction to close the drain outlet.
2. To drain the accumulated water, rotate the drain cap in the counterclockwise direction to open the drain outlet.

Note

The amount of accumulated hot water may decrease slightly in an amount that does not affect use. A small amount of water may flow out, which does not affect use. If the decreasing level is significant, the gasket of the drain cap may have deteriorated or become worn. Replace the drain cap. (Available at additional cost.)

⚠ Caution

- The amount of water should be below the level shown by the dotted line in the illustration on the below (just below the shower hose slot). When water accumulates and exceeds the dotted line, water may overflow from the shower hose slot.
- Do not move the basin with water in it. Failure to take this precaution may result in overflow of water from the basin or splashing of water over your closest dealer.
- Do not leave the showerhead in the water. Water may flow back when the water pressure in the water pipe decreases during a water outage.
- When the drainage speed slows, there is a possibility that dust and dirt may have clogged the drainpipe. Immediately stop using the product and contact your closest dealer.

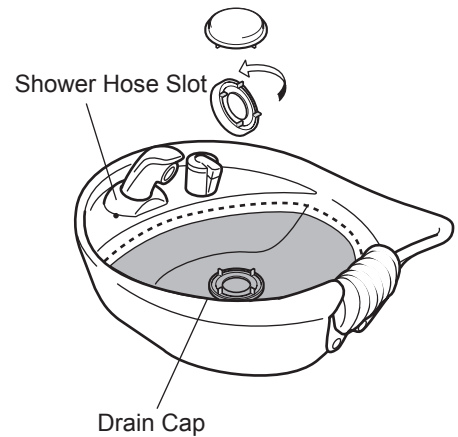

Guiding Clients

- 1 Ask client to seat on the chair and apply shampoo cloth.
- 2 Set the client in the chair and swing the shampoo basin to the shampoo position.

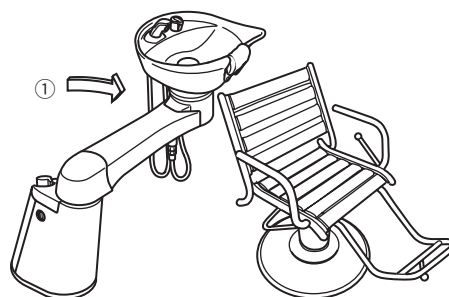

Caution

Ensure that the unit arm is fully swung to its maximum until it stops moving and fixes. Failure to follow this instructions may make the basin to move during shampooing, causing leakage or wetting client's clothes.

- 3 Adjust the seat height and backrest angle to the suitable position.

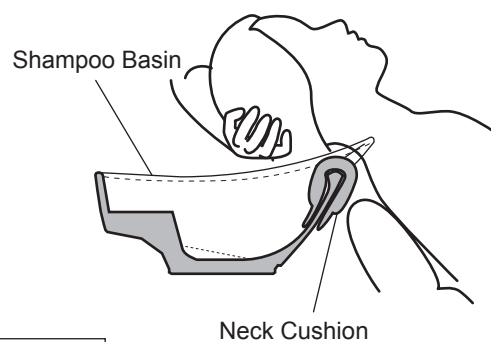

Caution

When reclining the backrest, hold the client's head by your hand to avoid client's head to hit the basin.

4 Shampooing, etc.

- The unit adopts low-splash, aerating shower head. However, water may drop to the floor depending on the shampooing way. Please take note of the followings when performing shampooing.

(1) Do not touch the client hair with the shower head.

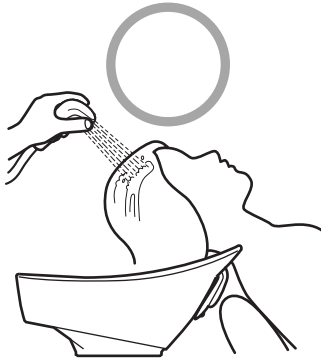

(2) Please hold the shower head at the head portion.

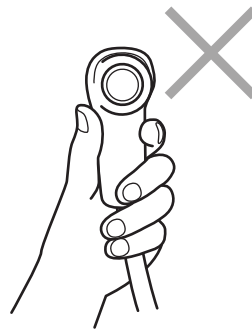
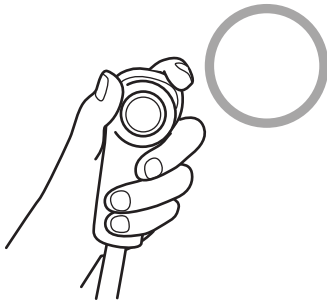

5 After shampooing, raise the chair backrest while supporting the client's head by your hand.

Caution Always support the client's head by your hand when raising the chair backrest.

6 Swing back the basin to its original position or the middle position.

*The "middle position" is available for 1200 pitch type only.

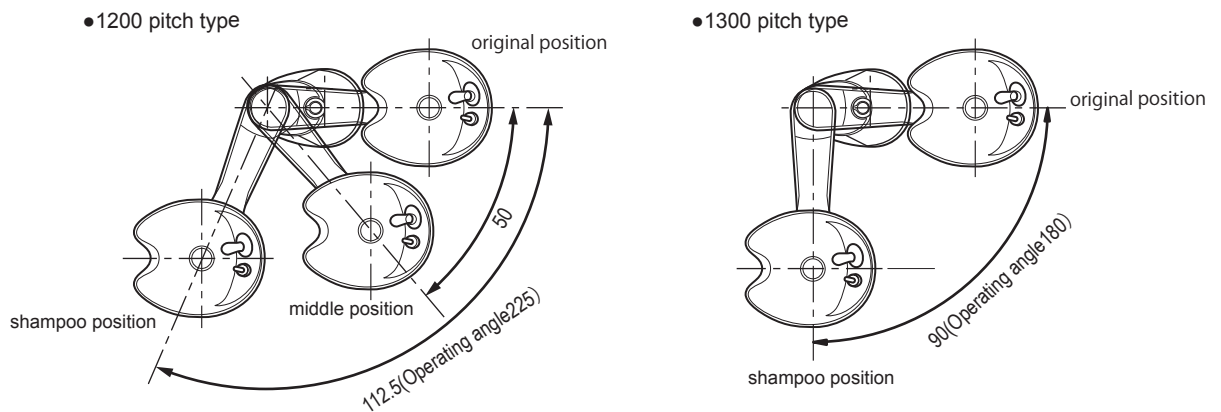

Caution When moving the basin, please be careful not to hit surrounding people/objects.

7 Remove the shampoo cloth.

8 After shampooing, wipe off any moisture.

- Moisture attached to the basin cover and external parts of the basin
- Moisture dropped on the floor through shower hose

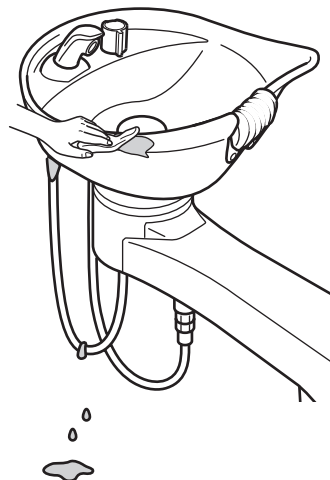

Caution After use, be sure to wipe off any moisture from all parts other than the basin. Leaving the product with water drops may result in failure of the product or any contamination will not be removed.

Maintenance

Never use volatile chemicals such as thinners, alcohol, gasoline or kerosene, cleaning products such as abrasive wax, a sponge with a scourer, detergents that include organic solvents, acidic, alkaline or chlorine-based detergents, or scouring pads. Failure to follow this instruction may cause scratches or discoloration.

⚠ Caution

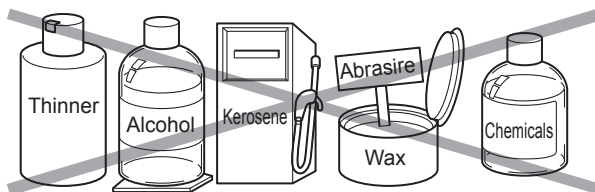

■ Shampoo basin

Wipe any dirt clean using detergent diluted with water. If streaked scratches appear due to contact with metallic objects such as watch bands, rub the area with a nylon scourer.

⚠ **Caution** Do not use a metallic scourer or sandpaper, as this will damage the basin.



The fixing pins are designed to be detachable. Be careful not to lose them.

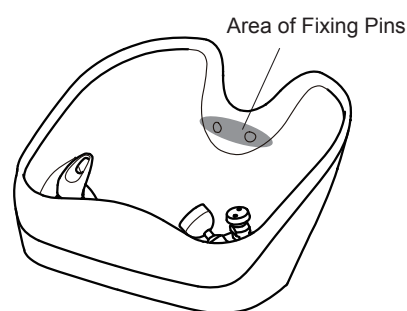

The area around the fixing pins of the neck cushion should be carefully cleaned with a cotton-tipped swab.

■ Drain cap packing

Wash around the drain cap, and remove any hair or dirt from solvents. If it is extremely dirty, remove the packing from the drain cap, wash with detergent solution diluted using water, and rinse carefully with water. The drain cap packing is a consumable supply. Replace the packing if degradation causes water to leak quickly when the basin is filled with water. (fee required)

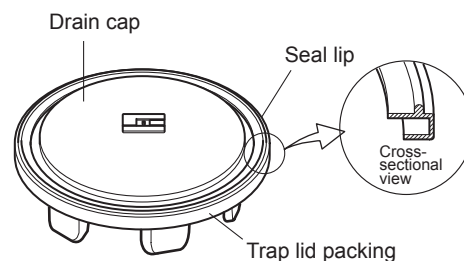

Take care of the orientation when removing or assembling the trap lid packing. If the packing is assembled upside down, water leakage will not be stopped.

remove any hair or dirt from solvents. Replace the packing if degradation causes water to leak quickly when the basin is filled with water. (available at additional cost)

■ Cover

Wipe clean with a soft, dry cloth. If they are extremely dirty, wipe with detergent diluted with water, and always wipe them dry.



⚠ Caution

Never use volatile chemicals such as thinners, alcohol, nail polish remover, gasoline or kerosene, cleaning products such as wax with a scourer, a sponge with a scourer, detergents that include organic solvents, acidic, alkaline or chlorine-based detergents, or scouring pads. Failure to follow this instruction may cause scratches or discoloration.

■Hair Catcher

Pull out the hair catcher located under the drain cover and remove any hair that has been caught. The hair catcher is a consumable supply. Replace the hair catcher if it is extremely dirty or the surface has deteriorated. (available at additional cost)

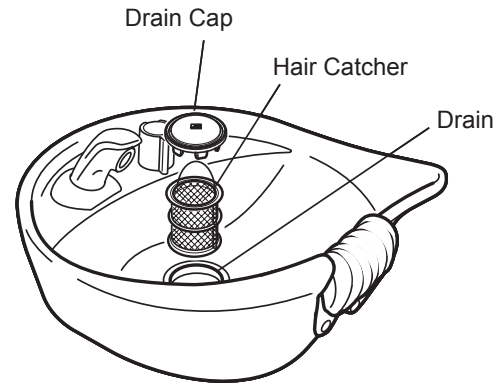

Caution

Clean the hair catcher as regularly as possible. Continuing to use the hair catcher without cleaning can cause the drain to become blocked with hair, leading to water overflowing and unhygienic conditions. Try to clean the hair catcher after each shampoo.

■Showerhead Holder, Tap, Temperature Control Knob

Wipe off the dirt with a soft cotton or towel with detergent solution diluted using water.



Caution

- Even when using a sponge for home use, continuous use may scratch the surface, so never use sponge.
- Never use abrasive wax, a sponge with a scourer, wire wool, nylon scourer, etc. as it may get surface scratched.
- Do not use chlorine-based detergent and strongly acidic detergent as it may peel off the surface plating.
- If the plating of resin (plating) parts such as tap is peeling off, immediately stop using the product and contact the nearest dealer or Takara Belmont directly. Peeled off parts or flaws may cause injury to your hands, etc.

■ Showerhead

- 1 The air bubble area of the showerhead should be cleaned once a month (as a general guide). Apply the supplied wrench to the chamfered portion of the air bubble fixture.



Caution

Be careful not to pinch your hand or finger in the wrench.

- 2 Rotate and loosen the air bubble fixture with the wrench.
- 3 Remove the three parts (rubber gasket, air bubble unit, and air bubble fixture) and wash with water using a nylon or similar brush.



Caution

The air bubble unit should be rinsed with running water in the direction shown in the illustration below:

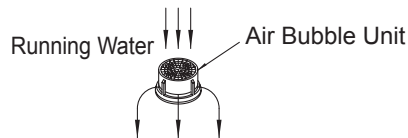

- 4 After cleaning, set the three parts in the order shown in the illustration.
- 5 Tighten the air bubble fixture with the wrench. This completes the cleaning.

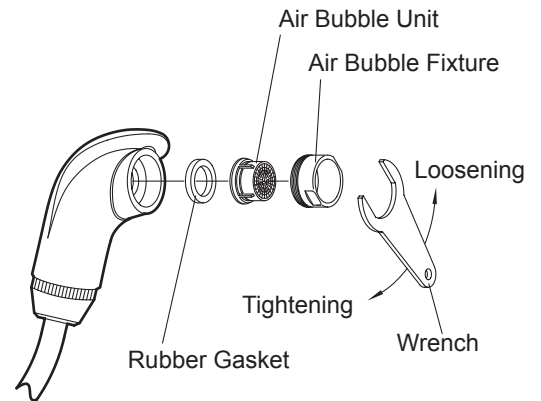

The air bubble unit and the gasket can be reused after washing with water.

If replacements are required due to deterioration or breakage, however, contact your closest dealer.

■ Neck cushion

At the end of work each day, wash the neck cushion with water, wipe them dry with a towel, and allow them to dry in the shade.

If they are extremely dirty, wash with detergent diluted with water, and rinse carefully with water.

The neck cushion is a consumable supply. Replace it if it is extremely dirty or the surface has deteriorated.(available at additional cost)



Caution

- If solvents drip onto the neck cushion, rinse with water as soon as possible. Failure to follow this instruction may cause deformation or discoloration.
- Clean the neck cushion every day. Leaving dirt uncleaned may cause them to get moldy.

■Maintenance of the inside of the main unit <water draining and cleaning procedures>

To use the basin for a long period of time, clean the strainer (inside the check valve) regularly.
If temperatures are expected to drop below freezing in cold regions, drain the water from the check valve.



Caution

In cold regions, always drain the water as a measure to prevent freezing. Failure to follow this instruction may cause water leakage.

- 1 Prepare cloth (two or more) to soak up water.
- 2 Detach the maintenance cover.
The cover can be detached by pulling horizontally, while gently pressing the cover sides.



Caution

- When operating water draining and cleaning procedures for the filter, pay attention water does not split to electric parts nearby. Failure to follow this caution may result in malfunction of the product or electrical leakage, resulting in fire.
- The hot water supply pipe may become very hot. Take care not to touch the pipe directly.
- After removing the maintenance cover, check that there is no water leakage within the basin. If there is water leakage, the pipes within the basin may be damaged.



When removing maintenance cover and plumbing cover, pay attention those parts will not hit the rotation arm cover.

- 3 Close stop valves of the hot water and water supply pipes.



To prevent water leakage, always check that the stop valves are completely closed before executing cleaning, or draining the water from the filters.

- 4 When the strainer is detached, the water in the pipe will come out. Therefore, rotate and detach the strainers of the check valves for hot water and water, while catching the water in a container.



Caution

- Removing the strainer from the hot water supply pipe may cause hot water to spill out. Take extra care when draining the hot water.
- The drain nut and strainer should be tightened firmly. If they are not, there is a possibility of water leaks.
- If the drain water spills onto the floor, immediately wipe it up.



Execute these processes for both water supply pipe and hot water supply pipe.

- 5 After completely draining the water from the check valve, clean the strainer by removing dust and dirt, set it in the original position, and tighten firmly. (Tool required: a blade-head screwdriver)

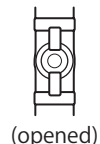
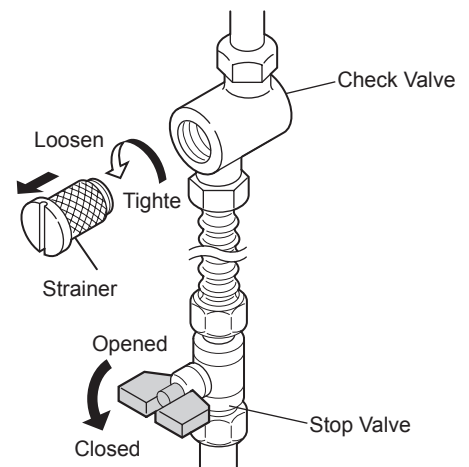
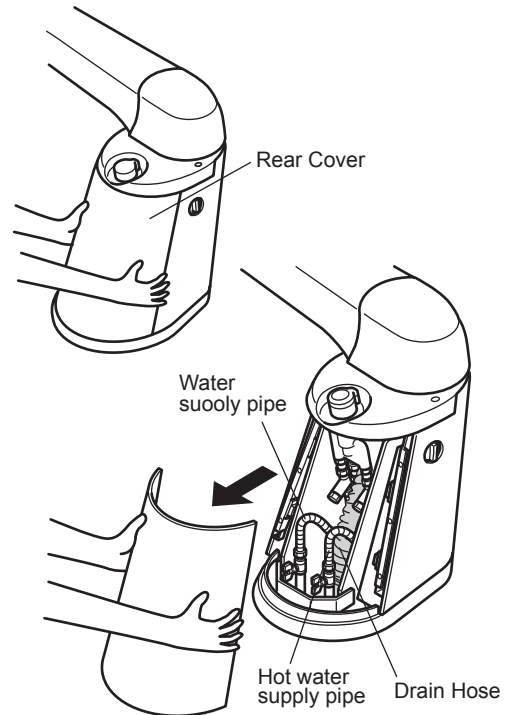

6 After checking that the strainers have been fastened properly, open the stop valves.
Check that there are no water leaks from the check valve.

7 Mount the Rear cover onto the main unit.

<Checking for water leakage>

Open the rear cover once per week (measure):

- Check that water is not leaking onto the floor.
- Check that there is no water leakage inside of the basin unit.

If there is water leakage, the basin unit or pipes in the rotation arm may be damaged, so contact the nearest dealer or Takara Belmont directly.

■ **Stop Valve Knob**

Open the Stop Valve at the beginning of the day and close it at the end of the day.

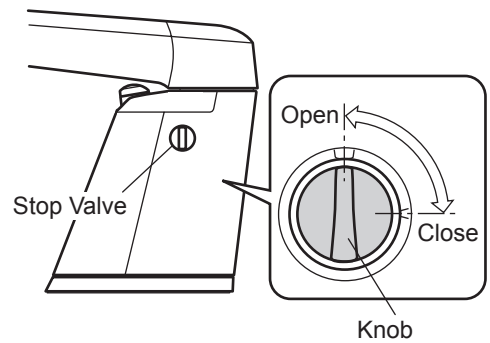

■ **Water removal (by removing the drain plug)**

In cold regions where freezing can be expected, when you feel drain empties slowly, or when you accidentally drop something in the drain, remove the drain plug and remove remaining water.



In cold regions, always drain the water as a measure to prevent freezing. Failure to follow this instruction may cause water leakage.

1 Prepare a container for collecting water.

2 Hold the container under the basin and loosen the drain plug to take it off the unit.

3 After water removal is finished, tighten back the drain plug into the unit.

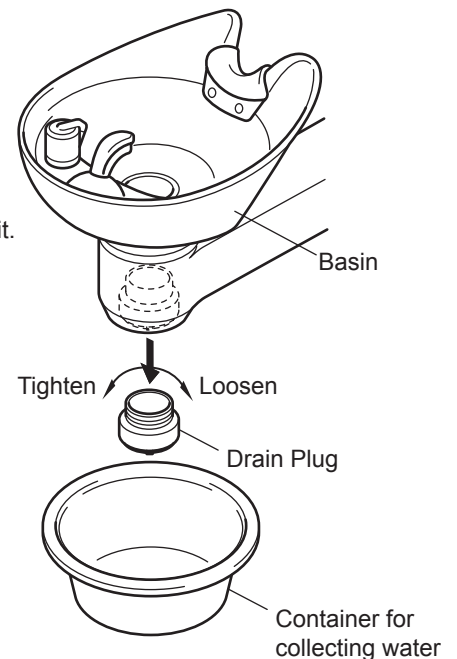

Caution

- Make sure to tightly tighten the drain plug. Otherwise, it may cause water leakage.
- Immediately wipe off any water spilled on the floor.

• To ensure that this product can be used for a long period of time, follow the procedures outlined in "Procedures for Daily Inspections" on page 26 to 27 of this instruction manual.



Always inspect this product following the procedures outlined in "Procedures for Daily Inspections". Continuing to use this product without performing the daily inspections may cause malfunctions or accidents.

The following are parts that must be replaced on a regular basis as designated by our company:

- Drain hose: Replace every three years
 - For the drain hose, there is a possibility that water leaks will occur because cracks are caused due to deterioration and hardening of the hose from chemical agents in the drain water.
 - Damage to the hose may result in water flooding on or beneath the floor.
- Check valve: Replace every three years
 - When the check valve is used continuously for long periods of time, there is a possibility that the parts in the valve will deteriorate resulting in no water discharging, or sometimes, the sewage water once discharged from the water faucet will flow back, thus causing contamination of city water or public health problems.
- Water/hot-water supply hose: Replace every three years
 - For the water/hot-water supply hose, there is a possibility that cracks due to deterioration caused by equipment operation or residual chlorine or copper ions in the city water will cause water leaks.
 - Damage to the hose may result in water flooding on or beneath the floor.

The above-listed parts must be replaced on a regular basis to ensure and maintain safety and performance. Any part that is outside the designated replacement period must be replaced even if there is no problem during use. (The parts are available at additional cost.) Our company will not assume responsibility for any harm, damage, or defects attributed to any part that was not replaced within the designated period. For ordering replacement work, contact the Call Center.

If the following problems arise, conduct the checks outlined before requesting repairs.

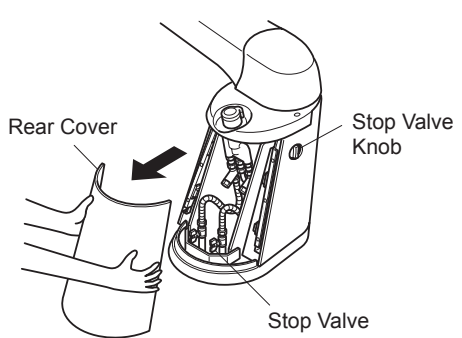
Symptom	Check this	Solution
<ul style="list-style-type: none"> • Water does not come out. 	 <p>→ Are the stop valve knob or water stop valves of the pipes open? (Refer to page 20.)</p>	Open the stop valve knob or stop valves. (Refer to page 20.)
<ul style="list-style-type: none"> • Sounds are generated when hot water is supplied. 	<p>→ Do the sounds vary when the hot water amount is adjusted at the tap?</p>	Adjust the volume of the water. (Refer to pages 11.)
<ul style="list-style-type: none"> • The water temperature is low. 	<p>→ Is the temperature setup of the boiler proper?</p>	Adjust the temperature setup of the boiler to the proper temperature.
	<p>→ Is the temperature setup of the temperature control knob proper?</p>	Adjust the temperature setup of the temperature control knob to the proper temperature. (Refer to page 15.)
<ul style="list-style-type: none"> • The water drains poorly from the drain outlet. 	<p>→ Is hair clogging the hair catcher?</p>	Remove the hair clogging the hair catcher. (Refer to page 18.)
<ul style="list-style-type: none"> • There is abnormal odor. 	<p>→ Is there any contamination on the basin?</p>	Wipe off any contamination.

If the product does not operate properly after checking and repairing the above points, stop using the product immediately.

Standard Duration of Use

The standard period of use of this product is seven years.

The standard period of use is "a guide for the standard period that this product can be used properly from a safety perspective, when conducting appropriate maintenance and inspections (including replacement of parts) for the standard usage conditions for each product." This is not the same as the warranty period.

Consumable Supplies

The following parts are "consumable supplies" and wear, degradation, changes in external appearance and damage are expected. Please note that repair or replacement of these parts is not covered by warranty, and a fee will be required. (*The level and period of wear, degradation or damage may differ depending on the environment and conditions that the client uses this product in.)

Inspections or replacement of parts will be required if extensive wear, degradation or damage occurs.

Consumable Parts (The following parts are not covered by the warranty; the cost of replacement is your responsibility.)

- Drain cap Hair catcher Rubber gasket, etc.
- Air Bubble unit of showerhead (air bubble unit, rubber gasket)
- Shower hose Neck cushion Lubricants (oil, grease, etc.)

Furthermore, flaws, contamination, deterioration, and discoloration of the exterior parts listed below are not covered by the warranty.

- Exterior parts
 - Covers, frames, and basin;
 - Other parts (Showerhead, showerhead holder, drain tap gasket , etc.)

Disposing of This Product

When disposing of this product or replaced parts, adhere with current regulations and dispose them appropriately according to the law in your country.

After-sales Service

To request after-sales service, contact your closest dealer or Takara Belmont directly.

Specifications

Product code	AY-RS2X * *	
Outside Dimensions	See the "Product Dimensions" on pages	
Neck height	900 mm	
Mixing type	Thermostat type	
Water discharging type discharging amount (hot-water pressure/water pressure: 0.1 NPa, respectively)	Air bubble water discharge : 8.0 L/min	
Water stop faucet	Single faucet (rotary type)	
Operating environment	Operating temperature: 10~40°C Operating humidity: 95% or below (No condensing)	
※Hot-water supply temperature	80°C or below	
※Hot-water/water supply pressure	<ul style="list-style-type: none"> •0.1~0.4MPa(1 to 4 kgf/cm²)² •Water supply pressure \geq Hot-water supply pressure² •Difference between hot-water supply pressure and water supply pressure: Within 0.2 MPa (2kgf/cm²) 	
Weight	AY-RS2X * *	55.0 kg

※For details of the hot-water supply temperature, hot-water/water supply pressures, see the RS SWING Installation Instructions.

Product Dimensions

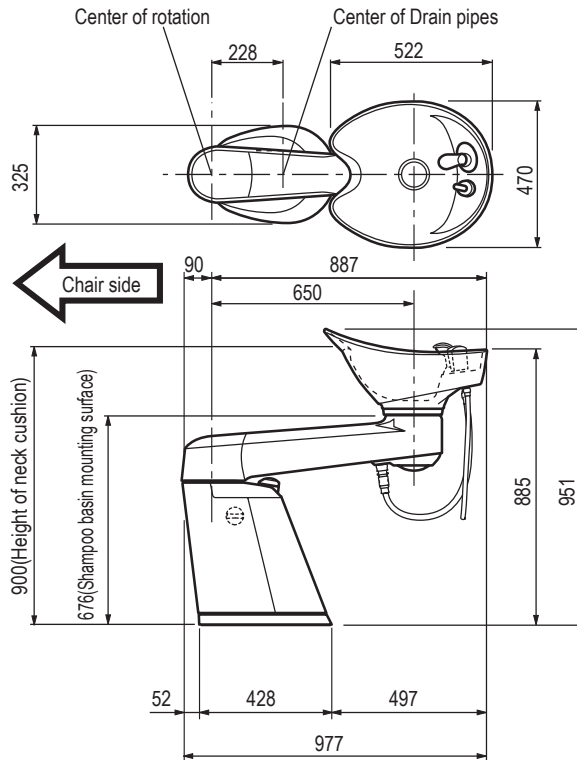

● 1200 pitch type

● 1300 pitch type

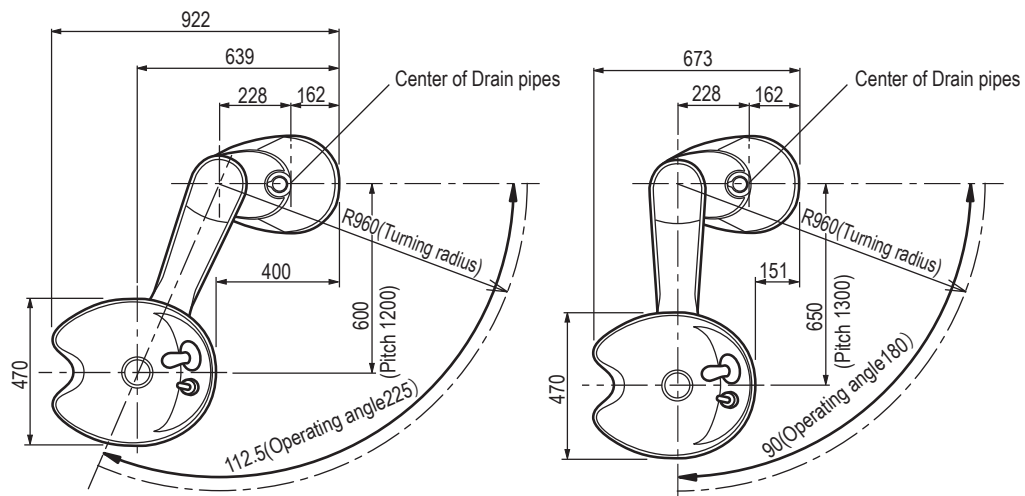

- ◆ Above measurement is subject to slight differences from product to product.
- ◆ Height from floor to neck cushion differs slightly from product to product.

Procedures for Daily Inspections

To ensure that this product can be used for a long period of time, conduct the inspections below.
When repair is necessary, contact the nearest dealer or Takara Belmont directly.

■ Inspect the product every day

Inspection item	Inspection method	If the inspection results show defects
<input type="checkbox"/> Is the plating of the water control knob peeled off?	<input type="checkbox"/> Visually check the water control knob for flaws, cracks, or peeling of the plated surface. <input type="checkbox"/> During operation or maintenance, check that there are no burrs or irregularities on the surface.	<input type="checkbox"/> Flaws, cracks, or peeling of the plated surface may result in injury of hand. If they exist, replacement of the knob is required. Contact your closest dealer.
<input type="checkbox"/> Is the basin unit not wet with water?	<input type="checkbox"/> Check if the parts except inside of the basin is not wet.	<input type="checkbox"/> It may cause malfunction of the product, or stain may become hard to remove. Immediately wipe away the moisture adheres on the parts except inside of the basin.
<input type="checkbox"/> Is the mounting surface of the basin unit not wet with water?	<input type="checkbox"/> Visually check the mounting surface of the basin unit and check it is not wet with water.	<input type="checkbox"/> There is a possibility that water is leaking inside of the basin unit. Open the maintenance cover and check inside (Refer to pages 20.). If water is leaking from the pipes, immediately stop using the product, contact the nearest dealer or Takara Belmont directly.
<input type="checkbox"/> Does the water control knob work properly?	<input type="checkbox"/> Turn the water control knob and check if warm water is output properly and that there is no abnormal noise, then close the water control knob and check that warm water stops properly.	<input type="checkbox"/> If there is abnormal noise or the water does not turn off properly when the water control knob is closed firmly, there may be a malfunction of the faucet.
<input type="checkbox"/> Does the temperature control knob work properly?	<input type="checkbox"/> Turn the temperature control knob, check that the water temperature is adjusted properly and that there is no abnormal sound. * An abnormal gushing sound may be emitted as water flows. (Refer to page 11.)	<input type="checkbox"/> If the water temperature cannot be adjusted properly or if there is abnormal sounds, there may be a problem with the thermostat inside of the basin unit. Stop using the product immediately, and contact the nearest dealer or Takara Belmont directly.
<input type="checkbox"/> Is water output from the showerhead properly?	<input type="checkbox"/> Turn on the tap, and visually check that water is discharged normally from the showerhead, water is not leaking from the air bubble unit, or the hot water is not turbid.	<input type="checkbox"/> If water is leaking from the air bubble unit or from the base of the showerhead, the internal packing may be worn out. If replacement is required, contact the nearest dealer or Takara Belmont directly. <input type="checkbox"/> If hot water does not come out normally, or it is turbid, there is a possibility that the filter of the check valve is contaminated. Clean the filter. (Refer to pages 20.) <input type="checkbox"/> When a few water line splashes out of the water flows, there is a possibility that water scale or dirt may be contaminated in the sprinkling filter unit. Remove the sprinkling filter unit and clean it. (Refer to page 19.)
<input type="checkbox"/> Is there any hair/objects caught in the drain cap?	<input type="checkbox"/> Check if there is any hair/objects caught in the drain cap.	<input type="checkbox"/> Remove any hair/objects caught in the drain cap.
<input type="checkbox"/> Is there an abnormal odor coming from the basin drain?	<input type="checkbox"/> Check if there is an abnormal odor coming from the basin drain	<input type="checkbox"/> Remove any hair and other objects trapped in the hair catcher. (see page 18)

Inspection item	Inspection method	If the inspection results show defects
<input type="checkbox"/> Can the basin be filled with water? <input type="checkbox"/> Has the neck cushion degraded?	<input type="checkbox"/> Check that the drain cover can block the drain when turning it over, and water filling in the basin does not drain. <input type="checkbox"/> Check that there is no tearing, dirt or sinking of the neck cushion surface.	<input type="checkbox"/> When the water decreases quickly, there is a possibility that the drain cap packing has deteriorated. The drain cap packing is a consumable part. For replacement, contact the nearest dealer of Takara Belmont directly. <input type="checkbox"/> These may cause pain or transfer dirt to the customer's neck and head. The neck cushion is consumable supplies. Replace it as soon as possible.

■ Items that must be inspected after closing for the day

Inspection item	Inspection method	If the inspection results show defects
<input type="checkbox"/> Is the drain blocked? <input type="checkbox"/> Has the water control knob been closed firmly?	<input type="checkbox"/> Check that the drain is not blocked with the drain cap, towel or shampoo cloth. <input type="checkbox"/> Close the water control knob firmly and check that the water turns off properly.	<input type="checkbox"/> Remove the object that is blocking the drain. If the drain is blocked, water that is turned on accidentally or a slight trickle of water due to an increase in water pressure at night may cause water to spill from the basin, leading to water leakage. <input type="checkbox"/> Close the water control knob firmly and turn the water off properly. If the water does not turn off completely, there may be a malfunction of the faucet. Close the stop valves in the water supply pipe and hot water supply pipe, and stop using the product immediately. (Refer to pages 20.)

■ Items that must be inspected once each week

Inspection item	Inspection method	If the inspection results show defects
<input type="checkbox"/> Is there any water scale or dirt blocking the sprinkling filter unit? <input type="checkbox"/> Is there any water leakage inside of the basin unit? <input type="checkbox"/> Is there any water leakage from the drain hose?	<input type="checkbox"/> Remove the sprinkling filter unit from the showerhead and check that there is no water scale or dirt on it. (Refer to pages 19.) <input type="checkbox"/> Remove the unit rear cover and check that there is no water leaking from the internal pipes or water taps (see page 20). <input type="checkbox"/> Remove the unit rear cover and check that there is no water leaking from the drain hose (see page 20).	<input type="checkbox"/> Use an item such as a toothbrush to remove any dirt such as water scale, and clean the sprinkling filter unit. Leaving the sprinkling filter unit unclean will lead to blockage, and water may not be output from the showerhead properly. <input type="checkbox"/> If water is leaking from the pipes, the pipes and packing may be worn, degraded or damaged. Close the stop valves in the water / hot water supply pipes (Refer to pages 24 to 26), immediately stop using the product, and contact the nearest dealer or Takara Belmont directly. <input type="checkbox"/> If water is leaking from the drain hose, the drain hose may be worn, degraded or damaged. Immediately stop using the product and contact the nearest dealer or Takara Belmont directly.



TAKARA BELMONT CORPORATION

1-1, 2-Chome, Higashi-shinsaibashi, Chuo-ku, Osaka, Japan

TEL : (06) 6213-5945

FAX : (06) 6212-3680

Printed in Japan

1E0511A0